



## Fitting and Operating Instructions XANA PLUS



### Warning

Please read these instructions carefully and keep them for future consultation. This heater must be installed by an accredited, qualified electrician and must observe Low Voltage Regulations. The installation as a whole should meet the provisions of aforesaid regulation. Any claim presented will be deemed invalid if the prevailing regulations have not been met.



## CONTENTS

---

INSTRUCTIONS FOR USE	3
General information	3
Description of the keypad and display	4
How to select a language	5
How to set the clock	6
How to raise or lower the room temperature	6
How to know whether or not a radiator is consuming power	7
How to block or unblock the keypad	7
How to activate or deactivate programmes	8
How to display the memorised programmes	10
How to customise programmes	11
How to reset the radiator	15
TROUBLESHOOTING	16
The Farho Xana Plus radiator is not responding to the controls	16
The radiator is not giving off heat	16
FITTER'S INSTRUCTIONS	18
Power Supply	18
Position	19
Fitting	20
TECHNICAL CHARACTERISTICS	21
CARE AND MAINTENANCE	21

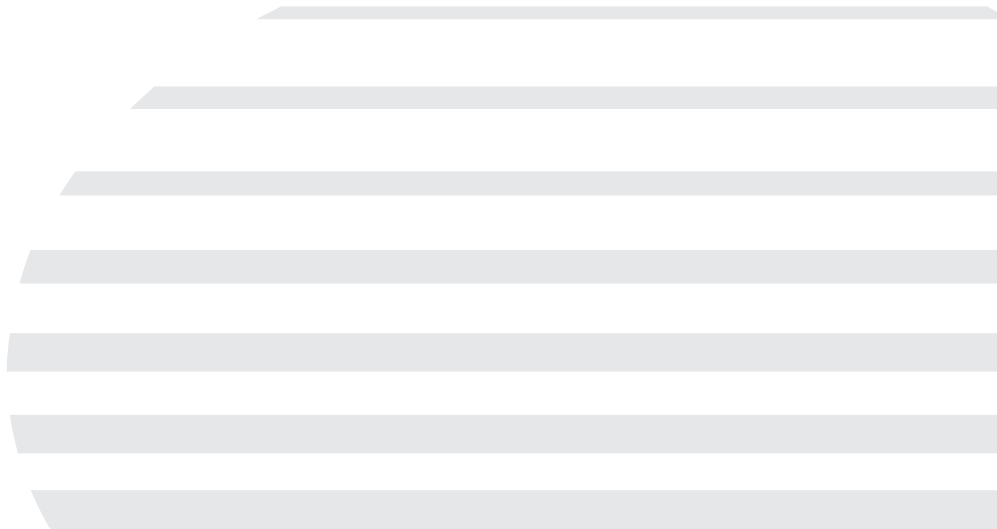



## INSTRUCTIONS FOR USE

### General Information

Thank you for purchasing a FARHO heater. This item has been manufactured in an ultra-modern, production-line process. It is noteworthy for its elegant shape, its user friendliness, its great heating power and the safety of its use and operation.

It has been designed and manufactured in accordance with domestic appliance requirements pursuant to EN 60950, EN 300 220, EN 301 489, EN60335-1, EN60335-2-30 Standards.

This product has been tested at an authorised laboratory in accordance with aforementioned standards.

A heater is an appliance that uses the electric current it receives to transform it into heat and to emit said heat in the space in which it has been fitted according to the user's heating requirements.

Correctly sized, the heater will provide sufficient heat to keep the space in which it has been fitted warm, in accordance with the user's requirements. A well-insulated house is obviously an advantage and will help to keep heating costs down.

After your heating system has been installed, you will want to make sure that the heat coming from same remains inside the house. This is why insulation is so important.

In addition to providing added value, the insulation prevents your money – quite literally – from escaping through the doors, the roof, the walls, the windows, etc. Consequently, if we fit weather slips in the windows, or if we change single-paned windows for double-glazed ones and insulate roofs and walls we will manage to keep the cold outdoors and the heat indoors. Moreover, a well insulated house is much cooler in the summer.

DO NOT COVER the heater surfaces, given that these will be hot. DO NOT PLACE inflammable articles, or those in danger of catching fire, on the heaters. Consequently, clothes, towels, magazines, spray cans and volatile substances or objects within at least 25 cm of the heater.

## DESCRIPTION OF THE KEYPAD AND DISPLAY



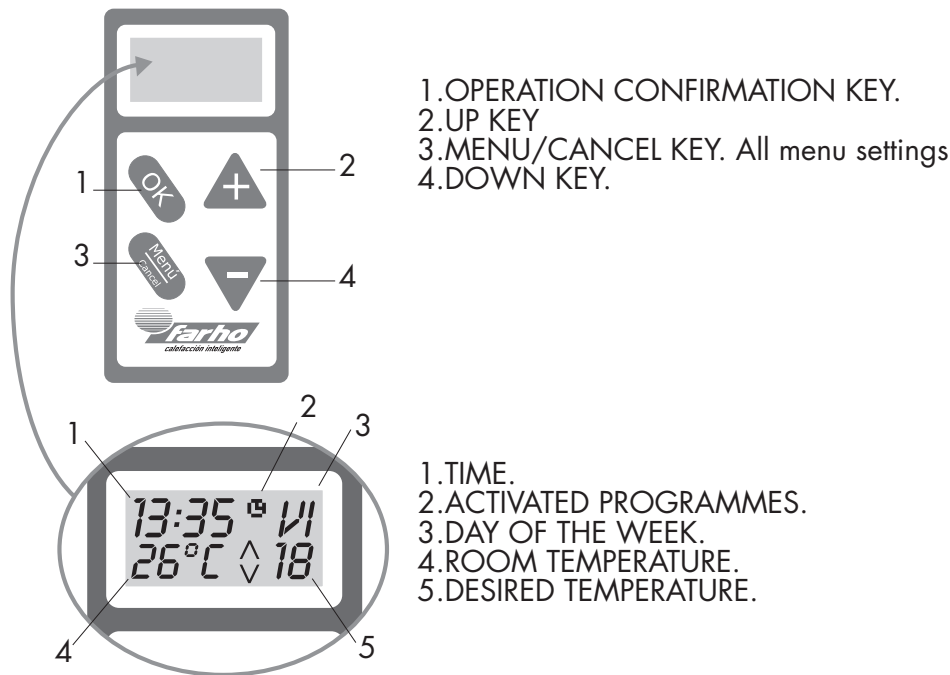

The XANA PLUS model is controlled by means of intuitive menus, thus greatly facilitating the use of same.



1. OPERATION CONFIRMATION KEY.
2. UP KEY
3. MENU/CANCEL KEY. All menu settings
4. DOWN KEY.

1. TIME.
2. ACTIVATED PROGRAMMES.
3. DAY OF THE WEEK.
4. ROOM TEMPERATURE.
5. DESIRED TEMPERATURE.



All you have to do to access the menu is to press the  key and scroll down by means of the  and  keys. Press the  key of the options menu in order to select one of the menu options. To return to the previous menu, simply press the  key again.

## HOW TO SELECT A LANGUAGE



Go to the "Settings" menu and select the language you require in the "Language" section.

The FARHO XANA PLUS model enables you to select the language that best suits you as regards handling the radiator. The following languages are available in this model: Spanish, Catalan, Basque, Galician, German, French, Hungarian, English, Italian and Portuguese.

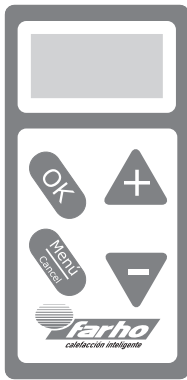

Follow the steps below to change the menu language:



1. Press the **Menu** key.
2. Press the **▶** key ONCE, which will make the "▶" indicator position itself in front of "Settings".
3. Press the **OK** key.
4. Press the **▶** key ONCE, which will make the "▶" indicator position itself in front of "Languages".
5. Press the **OK** key.
6. Press the **▲** and **▼** keys in order to scroll down the menu, and position the "▶" indicator in front of the desired "Language".
7. Press the **OK** key.









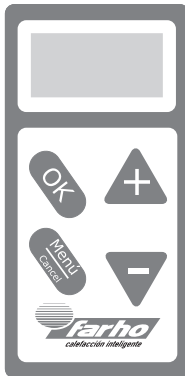



## HOW TO SET THE CLOCK



Go to the "Settings" menu. Once there, select "Time". Use the  and  keys to select the right hour setting and accept with the  key when you are ready. Do the same with the minutes and the date.



In order to set the time in the radiator, follow the steps given below:





1. Press the  key.
2. Press the  key ONCE, which will make the "▶" indicator position itself in front of "Settings".
3. Press the  key.
4. The "▶" indicator will now be positioned in front of "Time". Press the  key again.
5. Press the  and  keys to enter the correct hour setting.
6. Press the  key.
7. Press the  and  keys to enter the correct minute setting.
8. Press the  key.
9. Press the  and  keys to enter the correct day of the week.
10. Press the  key.

## HOW TO RAISE OR LOWER THE ROOM TEMPERATURE



Press the  and  keys to raise and lower the operating temperature, respectively.

To raise or lower the room temperature all you have to do is to simply press the  and  keys until the temperature indicator displays the desired heat level. The FARHO heater will automatically adjust the heat emission efficiently until reaching the temperature level you have set.



## HOW TO KNOW WHETHER OR NOT A RADIATOR IS CONSUMING



If the heater is in the consumption mode the pre-set temperature indicator on the display will flicker. If it is not flickering, the heater is in the idle mode.



The FARHO XANA PLUS heater will indicate at all times whether or not it is consuming power or not. When it is not consuming power it is in the idle mode.

Look at the radiator display screen. If the pre-set temperature indicator is flickering, the radiator is in the consumption mode. Contrariwise, if the indicator is not flickering this means that it is in the idle mode.

## HOW TO BLOCK OR UNBLOCK THE KEYPAD



Press on the  key for four seconds in order to block or unblock the keypad.

The FARHO XANA PLUS model heaters have a keypad blocking function to avoid its handling by children, or unauthorised persons.

### *How to block the keypad:*

Press on the  key for four seconds. The keypad will now be blocked. If you press on any of the keys, the radiator will not respond to the orders. The screen will simply display the word "Blocked".

### *How to unblock the keypad:*

Press on the  key for four seconds. The keypad will now be unblocked.



## HOW TO ACTIVATE OR DEACTIVATE PROGRAMMES



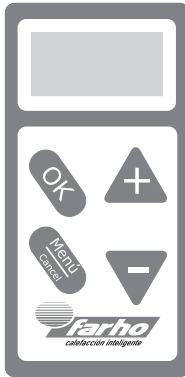

Go to the "Programmes" menu, select "Activate" or "Deactivate". If the programmes are active, only the "Deactivate" option will come up on the menu, and vice versa.



To activate programmes follow the steps given below:

1. Press the  key.
2. The "▶" indicator will position itself in front of "Programmes". Press the  key.
3. The indicator "▶" will be in front of "Activate". Press the  key. The programmes have now been activated. (Note: If on reaching this step the "▶" indicator is positioned in front of the word "Deactivate" instead of "Activate", this means that programmes had already been activated).

To deactivate programmes follow the steps given below:

1. Press the  key.
2. The "▶" indicator will position itself in front of "Programmes". Press the  key.
3. The indicator "▶" will be in front of "Deactivate". Press the  key. The programmes have now been deactivated. (Note: If on reaching this step the "▶" indicator is positioned in front of the word "Activate" instead of "Deactivate", this means that programmes had already been deactivated).

When the programmes have been activated, the “” symbol will come up on the start menu display screen.

The FARHO XANA PLUS model has default programmes stored in its memory. These can be modified by the user should he or she so wish. (See the section entitled “HOW TO CUSTOMISE PROGRAMMES” in this manual).

The pre-set, default programmes stored in the XANA PLUS model memory are indicated in the following table.

TIME ZONE	DAY OF THE WEEK						
	MONDAY	TUESDAY	WEDNESDAY	THURSDAY	FRIDAY	SATURDAY	SUNDAY
1	START 00:00	START 00:00	START 00:00	START 00:00	START 00:00	START 00:00	START 00:00
	FINISH 07:00	FINISH 07:00	FINISH 07:00	FINISH 07:00	FINISH 07:00	FINISH 07:00	FINISH 07:00
	TEMP. 18	TEMP. 18	TEMP. 18	TEMP. 18	TEMP. 18	TEMP. 18	TEMP. 18
2	START 07:00	START 07:00	START 07:00	START 07:00	START 07:00	START 07:00	START 07:00
	FINISH 09:00	FINISH 09:00	FINISH 09:00	FINISH 09:00	FINISH 09:00	FINISH 09:00	FINISH 09:00
	TEMP. 21	TEMP. 21	TEMP. 21	TEMP. 21	TEMP. 21	TEMP. 21	TEMP. 21
3	START 09:00	START 09:00	START 09:00	START 09:00	START 09:00	START 09:00	START 09:00
	FINISH 14:00	FINISH 14:00	FINISH 14:00	FIISHN 14:00	FINISH 14:00	FINISH 14:00	FINISH 14:00
	TEMP. 18	TEMP. 18	TEMP. 18	TEMP. 18	TEMP. 18	TEMP. 18	TEMP. 18
4	START 14:00	START 14:00	START 14:00	START 14:00	START 14:00	START 14:00	START 14:00
	FINISH 15:30	FINISH 15:30	FINISH 15:30	FINISH 15:30	FINISH 15:30	FINISH 15:30	FINISH 15:30
	TEMP. 21	TEMP. 21	TEMP. 21	TEMP. 21	TEMP. 21	TEMP. 21	TEMP. 21
5	START 15:30	START 15:30	START 15:30	START 15:30	START 15:30	START 15:30	START 15:30
	FINISH 20:00	FINISH 20:00	FINISH 20:00	FINISH 20:00	FINISH 20:00	FINISH 20:00	FINISH 20:00
	TEMP. 18	TEMP. 18	TEMP. 18	TEMP. 18	TEMP. 18	TEMP. 18	TEMP. 18
6	START 20:00	START 20:00	START 20:00	START 20:00	START 20:00	START 20:00	START 20:00
	FINISH 00:00	FINISH 00:00	FINISH 00:00	FINISH 00:00	FINISH 00:00	FINISH 00:00	FINISH 00:00
	TEMP. 21	TEMP. 21	TEMP. 21	TEMP. 21	TEMP. 21	TEMP. 21	TEMP. 21

## HOW TO DISPLAY THE MEMORISED PROGRAMMES?



Go to the "Programmes" menu and then to the "Display" menu. Choose the day of the week for which you wish to display the pre-set programmes and after selecting same, scroll up and down the menu in order to see the different time zone settings.

If you wish to see what programmes that have been memorised, you can display them at any given time as follows:



1. Press the key.
2. The "▶" indicator will position itself in front of "Programmes". Press the key.
3. Press the key, which will make the "▶" indicator position itself in front "Display".
4. Press the key.
5. Press or in order to scroll down the menu, thus positioning the indicator "▶" in front of the day of the week for which you wish to display the programmes. Press the key.
6. Press or in order to scroll down the menu and
7. display the programmes that have been memorised for the day in question. Remember that you can always press the key to
8. return to the previous menu.

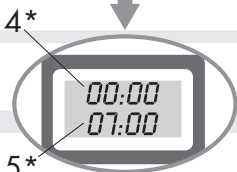
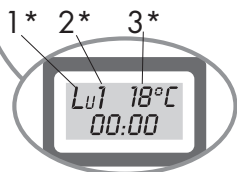

- 1\* Day of the week.
- 2\* Time zone. (Each day is divided into 6 different time zones).
- 3\* Pre-set temperature.
- 4\* Time zone start time.
- 5\* Time zone finish time.
- 6\* Time zone dividing line.

## HOW TO CUSTOMISE PROGRAMMES?



Go to the "Programmes" menu and from there on to the "Edit" menu. Select the day of the week for which you wish to customise the programmes. Next, select "Accept" by pressing the key. Use the , and keys to choose and accept the start and finish operating time and temperature settings for the time zone in question. Repeat this operation for each time zone (bear in mind you have six). If you do not wish to enter any more time zones, press the key at the beginning of a new one.





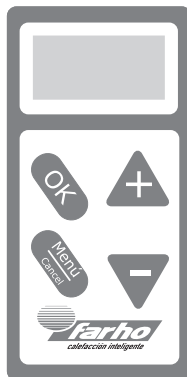



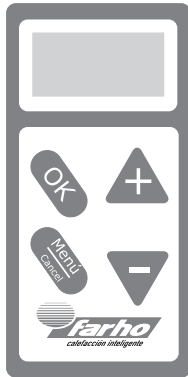









The FARHO XANA PLUS model enables you to customise, in a centralised fashion, operating programmes of radiators so that these may better meet your heating needs. You can customise radiator programmes for every day of the week, and include up to six operating time zones for each one, with its own associated operating temperature.

In order to aid you in setting down the operating parameters that most suit your routine, we have included a table (See page 13) on which you can choose your time zone start and finish times, as well as the operating temperature corresponding to each one of same.



1. Press the key.
2. The "▶" indicator will now position itself in front of "Programmes". Press the key.
3. Press the key TWICE, thus the "▶" indicator will be positioned in front of "Edit".
4. Press the key.
5. Press or in order to scroll down the menu in order to position the indicator "▶" in front of the day of the week on which you wish to customise the programmes. Press the key. The "□" symbol on the display
6. screen to the right of the selected day should now have turned into the following "☒" symbol indicating that the day in question has been selected.



7. Repeat Step 5 and Step 6 until you have selected all of the days of the week on which you wish to implement the programme in question.
8. Press the  key until positioning the "▶" indicator in front of "Accept".
9. Press the  key. A menu will come up showing the time zone that is being implemented and the word "ON", which indicates the time at which the time zone in question starts.
10. Press the  and  keys to enter the hour at which the time zone is to start.
11. Press the  key.
12. Press the  and  keys to enter the minute at which the time zone is to start.
13. Press the  key. A menu will come up showing the time zone that is being implemented and the word "OFF", which indicates that time at which the time zone in question finishes should be entered.
14. Press the  and  keys to enter the hour at which the time zone is to finish.
15. Press the  key.
16. Press the  and  keys to enter the minute at which the time zone is to finish.
17. Press the  key.
18. Press the  and  keys to enter the desired operating temperature for the time zone in question.
19. Press the  key.
20. If you have finished entering all the time zones for this programme, press the  key. If you wish to enter another time zone, repeat all the steps as of Step 10. Bear in mind that you have six time zones for each day of the week.

CUT ALONG THE LINES



TIME ZONE	DAY OF THE WEEK						
	MONDAY	TUESDAY	WEDNESDAY	THURSDAY	FRIDAY	SATURDAY	SUNDAY
1	START	START	START	START	START	START	START
	FINISH	FINISH	FINISH	FINISH	FINISH	FINISH	FINISH
	TEMP.	TEMP.	TEMP.	TEMP.	TEMP.	TEMP.	TEMP.
2	START	START	START	START	START	START	START
	FINISH	FINISH	FINISH	FINISH	FINISH	FINISH	FINISH
	TEMP.	TEMP.	TEMP.	TEMP.	TEMP.	TEMP.	TEMP.
3	START	START	START	START	START	START	START
	FINISH	FINISH	FINISH	FINISH	FINISH	FINISH	FINISH
	TEMP.	TEMP.	TEMP.	TEMP.	TEMP.	TEMP.	TEMP.
4	START	START	START	START	START	START	START
	FINISH	FINISH	FINISH	FINISH	FINISH	FINISH	FINISH
	TEMP.	TEMP.	TEMP.	TEMP.	TEMP.	TEMP.	TEMP.
5	START	START	START	START	START	START	START
	FINISH	FINISH	FINISH	FINISH	FINISH	FINISH	FINISH
	TEMP.	TEMP.	TEMP.	TEMP.	TEMP.	TEMP.	TEMP.
6	START	START	START	START	START	START	START
	FINISH	FINISH	FINISH	FINISH	FINISH	FINISH	FINISH
	TEMP.	TEMP.	TEMP.	TEMP.	TEMP.	TEMP.	TEMP.



14



## HOW TO RESET THE RADIATOR?



IF YOU RESET THE XANA PLUS RADIATOR MODEL ALL OF THE CUSTOMISED PROGRAMMES THAT YOU MAY HAVE STORED IN THE MEMORY WILL BE DELETED, AND WILL BE REPLACED BY THE PRE-SET, EX-FACTORY DEFAULT PROGRAMMES. IF YOU HAVE AN CENTRAL UNIT AND THE RADIATOR IS CONFIGURED TO OPERATE BY WAY OF SAME, AFTER RESETTING THE RADIATOR IT WILL HAVE TO BE RE-INSTALLED AGAIN (CONSULT THE SECTION ENTITLED "HOW TO INSTALL RADIATORS ON THE AUTOMATED NETWORK" IN THE FARHO LIFE STATION CENTRAL UNIT MANUAL).



Go to the "Settings" menu and then to the "Reset" menu. The radiator will ask you for confirmation. Use the , and keys to select and accept YES or NO, as appropriate.



1. Press the key.
2. Press the key ONCE, which will make the "▶" indicator position itself in front of "Settings".
3. Press the key.
4. Press the key TWICE, which will make the "▶" indicator position itself in front of "Reset".
5. Press the key.
6. The radiator will then request confirmation before resetting. Press the and keys to select "YES" or "NO".
7. Press the key. If you chose "YES", the radiator will now be reset.

## TROUBLESHOOTING

If your radiator is not working properly, or if you are having some trouble with the new FARHO automated home system, you may find a solution in the following list of possible problems:

### THE FARHO XANA PLUS IS NOT RESPONDING TO THE CONTROLS

Possible causes are:

\* If on pressing any of the FARHO XANA PLUS model keys the expected action is not brought about, and the word blocked comes up on the display screen, the radiator keypad has been blocked. To eliminate the keypad blocking function, consult the section entitled "HOW TO BLOCK OR UNBLOCK THE KEYPAD" in this manual.

\* If on pressing any of the FARHO XANA PLUS model keys the expected action is not brought about, disconnect the radiator by means of the switch on the underside of the keypad, wait for a few seconds and reconnect.

### THE RADIATOR IS NOT GIVING OFF HEAT

If room temperature is lower than the set temperature and the radiator is not heating up, this situation may be because:

\* The radiator is working, but it is still too early to perceive the heat. Check that the pre-set temperature indicator is flickering and wait for a few minutes.

\* The pre-set temperature indicator on the display is not flickering, but the room temperature is above the pre-set operating temperature. Disconnect the radiator by means of its switch, wait a few seconds and turn it on again.

\* Perhaps you have set the radiator operating output and this is not receiving permission from any central unit to come into operation. If you have a FARHO LIFE STATION Central Unit, or this is disconnected, and have set the radiator output on the menu of the FARHO XANA PLUS model radiator, go to the "Power" option in the "Settings" menu and position the power at 0. You can see if any power has already been set for each radiator in the "Info" option in your menu.

\* If you have a FARHO LIFE STATION Central Unit, check that the central unit output limiter is not activated. To this end, select the "Info" option on the FARHO LIFE STATION Central Unit menu and make sure that the symbols " \_ \_ \_ \_ \_ " follow the "Max. Power:" entry. If this is not the case, it means that the output limiter is activated and the FARHO LIFE STATION Central Unit could be preventing this radiator from working until other radiators reach their operating temperature. If you wish to disconnect the LIFE STATION Central Unit output limiter (Consult the section entitled "HOW TO DEACTIVATE THE OUTPUT CONTROL" in the LIFE STATION Central Unit operating manual).

## FITTER'S INSTRUCTIONS

### POWER SUPPLY

The FARHO radiator needs 230 V input.

It must be pointed out that the lead cable used to fit the FARHO XANA PLUS model must be of appropriate diameter in accordance with the length, type and power of the radiator in question (See Low Voltage Regulations). According the regulations, it must be possible to insulate the supply circuit by means of an omnipolar cut-off element, such as, for example, a break switch. The disconnecting contact must be at least 3 mm.

A plug can be used to connect the radiator as long as direct access can be had to the socket. Another possibility is to connect the radiator directly to a fixed installation by means of a blank case fitted with an internal terminal strip.

The heater should be connected to the mains only after it has been hung from the brackets that have been previously secured to the wall to hold it (Consult the section entitled "FITTING" in this manual).

The power lead must not lie against, or touch, any part of the heater. Whenever necessary, and in order to ensure avoidance of contact a cableway strip, clips or some other type of securing component will be employed. Perform the operations listed above in reverse order to disconnect the heater from the mains

## POSITION

The ideal position for the FARHO heater is to fit it as close as possible to the facing that suffers most heat loss. We do not recommend fitting it to non-insulated walls that give onto the exterior. Should this be necessary, the insulation of the surface onto which the heater is to be fitted needs to be increased.

Radiators should not be fitted within the safety protection area limit in bathrooms (i.e. 1 m on the horizontal from the edge of the bath tub and 2.25 m on the vertical from the back of same).

Under no circumstances whatsoever should the heater be installed under a tapping point.

There must be a minimum free space of 100 mm left between the sides of the FARHO heater and any item of furniture, curtains, etc.

The minimum distances in Figure 1 will be respected whenever choosing the position to fit the heater.

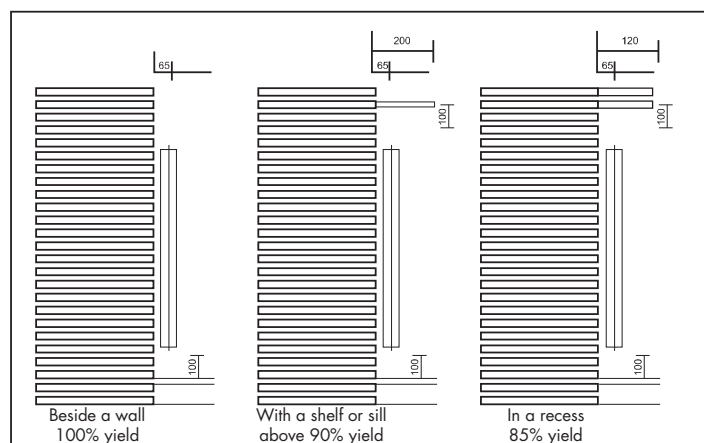

figure 1.

## FITTING

The FARHO heater will be mechanically secured to the wall at its top by means of the brackets that have been specially designed to this end, and which are supplied with the appliance.

Said brackets will be fitted at a centre distance of (Distance A); a distance that is set in Table 1 for the different models, and at height of 600 mm from the floor (Height B).

Model	Distance A mm.
XANA PLUS	160
XANA PLUS	320
XANA PLUS	480
XANA PLUS	640
XANA PLUS	800
XANA PLUS	960

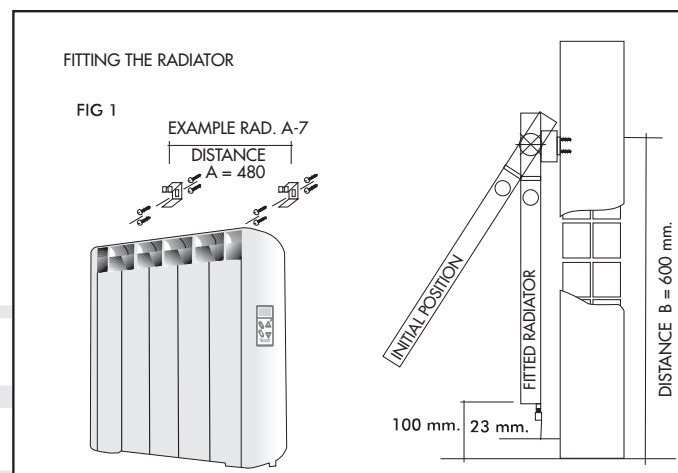

## TECHNICAL CHARACTERISTICS

MODEL XANA PLUS	Thermostat Description	Power Rating (W)	Dimension Width x depth x height (mm.)	Weight (Kg.)	Nº of Elements
XANA PLUS - 3	Digital / Programmable	360 / 393	370 x 95 x 590	7,5	3
XANA PLUS - 5	Digital / Programmable	601 / 655	530 x 95 x 590	11,5	5
XANA PLUS - 7	Digital / Programmable	842 / 916	690 x 95 x 590	15,5	7
XANA PLUS - 9	Digital / Programmable	1082 / 1178	850 x 95 x 590	19,5	9
XANA PLUS - 11	Digital / Programmable	1323 / 1440	1010 x 95 x 590	23,5	11
XANA PLUS - 13	Digital / Programmable	1500 / 1700	1170 x 95 x 590	27,5	13

## CARE AND MAINTENANCE

### **UNDER NO CIRCUMSTANCES WHATSOEVER SHOULD THE APPLIANCE BE COVERED!**

Let the "DO NOT COVER" warning on the upper face of the radiator serve the user as a constant reminder. Air must be freely able to enter into contact with all heater surfaces.

Use pH neutral detergents to clean the radiator.







## GUARANTEE TERMS AND CONDITIONS

Farho guarantees the proper and correct functioning of the appliance the data of which are given herein, as long as aforesaid appliance is used for domestic purposes. All Farho products must be installed by Certified Fitters. In the interest of safety, before starting the fitting operation, the Fitting Instructions that accompany each product must be read carefully.

The Farho factory is at your complete disposal for any repairs that might need to be carried out, as well as to ensure that your appliance works correctly throughout its useful life.

For YOU as a user, this means:

- < Security with respect to original spare parts
- < Personnel who are in possession of original documentation and who have been specifically trained by Farho to carry out repair work.



## **VERY IMPORTANT**

---

The following documents can be used in order to accredit the guarantee start date:

- 1.- The purchase bill, or the bill issued by the fitter upon its installation.
- 2.- Power supply contract in newly constructed installations or homes.
- 3.- Fitters' and Industry Official Gazette in the case of new installation, or dwelling, refurbishment.

If, upon the express request of the user, additional services were carried out at our installations that fall outside the scope of the guarantee, the additional cost of these services will not be covered by aforesaid guarantee.

All FARHO products must be fitted pursuant to prevailing regulations and in accordance with the operating and fitting instructions that accompany the product. Incorrect fitting, or whenever the appliance has not been fitted in accordance with the relevant regulations, will result in the total loss of guarantee cover.

## **GUARANTEE CLAUSES**

---

Important note concerning the validity of this guarantee: when requesting technical intervention in the factory, it is absolutely essential that the authorised personnel be presented with this certificate along with the duly completed bill of purchase.

Over the first six months after the purchase date, this GUARANTEE covers the repair at FARHO installations, of all flaws or defects and any damages arising thereof, or the replacement of any defective part or component, free of charge, including carriage charges to the factory and the labour costs involved in returning the appliance to proper and correct functioning order.

If, during this period, the repair carried out were not satisfactory and the appliance were not in perfect condition to fulfil the purpose for which it had been purchased, the holder of the guarantee would have the right to have the item in question replaced by one of identical characteristics. Where this is not possible the customer would receive a refund of the price paid for the appliance.

In the 18 months following the period of cover mentioned above, FARHO will replace any part, or defective component, free of charge, including carriage expenses to the factory, as well as the corresponding labour costs involved in repairing the appliance at our installations. As a complement to the aforementioned, FARHO guarantees its heater for a further period of eighteen years, except for carriage costs, which will be paid by the user.

## **WARNING**

---

FARHO will not be liable for damages produced by the possible appearance of stains on walls and ceilings provoked by dirt, dusty atmospheres or any other unhygienic circumstances of the premises where the heater is fitted.

## **CAUSES EXCLUDED FROM GUARANTEE**

---

- a) Breakdowns provoked by atmospheric or geological phenomena (frost, storms, rains, etc.) as well as those arising from inappropriate voltage.
- b) Parts or components that have received knocks during carriage or the fitting operation.
- c) Cleaning operations of the appliance, or parts thereof, provoked by dirt, grease or other circumstances related to the premises where the appliance has been fitted.
- d) Modifications to original FARHO products, without consulting the factory, or using spare parts that have not been recommended by FARHO.



**Customer Help Desk: 902 105 271**



FARHO S.L.U.  
 Polígono Industrial Tabaza II, Parcelas 9 a 13  
 Tlf.: (+34) 985 514 082 - (+34) 985 514 605  
 Fax: (+34) 985 514 164  
 33439 Carreño (Asturias)  
 www.farho.com

**LOW-CONSUMPTION FARHO ELECTRIC HEATERS**

- |   |   |   |
|---|---|---|
| Alejandria AN <input type="checkbox"/>      | Xana Plus <input type="checkbox"/>          | Nº <input type="text"/>                       |
| Elegance TDE <input type="checkbox"/>       | Heating Plus <input type="checkbox"/>       | W <input type="text"/> A <input type="text"/> |
| Elegance CDE <input type="checkbox"/>       | Towel Rack <input type="checkbox"/>         |   |
| U. C. Life Station <input type="checkbox"/> | Victory Towel Rack <input type="checkbox"/> |   |
|   | Nova Towel Rack <input type="checkbox"/>    |   |

Voltage 220/230 V.      50/60 Hz.  
 Distributed by: .....  
 Purchase date: ..... of ..... 200 .....

FITTER: .....

Name: ..... Town/City: .....  
 Address: ..... Phone: .....

**USER:**

Name: ..... Town/City: .....  
 Address: ..... Date appliance was put.....  
 into operation:

Nº ..... Fitter's stamp

*To be completed by fitter*











FARHO S.L.U.  
Polígono Industrial Tabaza II, Parcelas 9 a 13  
Tlf.: (+34) 985 514 082 - (+34) 985 514 605  
Fax: (+34) 985 514 164  
33439 Carreño (Asturias)  
www.farho.com

ISO 9001:2000 CERTIFICATE



ISO 14001:2004 CERTIFICATE



A la Iniciativa Empresarial

